



AirEther™ BR108

5.3 / 5.8 GHz OFDM

Point to Multipoint

WIRELESS BRIDGE

User Manual

Version 3.2b

PREVIOUS HISTORY

Revision	Date of Issue	Scope
0.0	March 31, 2004	Initial
1.0	April 2, 2004	First draft
2.0	April 2, 2004	Correct errors and the paragraph orders
2.5	May 25, 2004	Second draft
3.0	June 15, 2004	Edit the third part and correct errors
3.1a	Dec. 30, 2004	Add the third part and correct errors
3.2a	April. 10, 2005	Correct errors and add feature
3.2b	July 14, 2006	Wording Update



FCC Notice:

This equipment has been tested and found to comply with the limits for a Class B digital device, pursuant to Part 15 of the FCC Rules. These limits are designed to provide reasonable protection against harmful interference in a residential installation. This equipment generates uses and can radiate radio frequency energy and, if not installed and used in accordance with the instructions, may cause harmful interference to radio communications. However, there is no guarantee that interference will not occur in a particular installation. If this equipment does cause harmful interference to radio or television reception, which can be determined by turning the equipment off and on, the user is encouraged to try to correct the interference by one or more of the following measures:

- Reorient or relocate the receiving antenna.
- Increase the separation between the equipment and receiver.
- Connect the equipment into an outlet on a circuit different from that to which the receiver is connected.
- Consult the dealer or an experienced radio/TV technician for help.

Changes or modifications not expressly approved by the party responsible for compliance could void the user's authority to operate the equipment.

This device and its antenna(s) must not be co-located or operating in conjunction with any other antenna or transmitter

PREFACE

We are so honored to offer you this product – “AirEther BR108 Wireless Outdoor Bridge”. The AirEther BR108 Wireless Outdoor Bridge is cost-effective to expand or relocate your local wired networks (LANs). This advanced design suits the goal to create an unwired working environment.

The AirEther BR108 with IEEE 802.11a feature is the wireless solution for building-to-building. The AirEther BR108 provides the data rate up to 108 Mbps and is suited for enterprises, campus or off-site locations that require LAN or Internet access without the availability of wired networks to extend network coverage.

The AirEther BR108 provides point-to-point and point-to-multi-point connection capabilities. The wireless building-to-building bridging solution contains a state-of-the-art wireless Bridge, high gain performance antenna and power-over-Ethernet technology. For further protection, the bridge and power-over-Ethernet adapter have built in lightning protector.

The AirEther BR108 provides the alternative solution for last-mile connection. By leveraging the IEEE 802.11's volume power and low cost, AirEther BR108 Link provides very cost effective solution to carriers. With the cost effective wireless last mile solution, service provider can have fast deployment (time-to-market) and successful business models.

The document is for your information to know more detail about AirEther BR108 Weather proof Wireless Outdoor Bridge. We will introduce the hardware part, the software configuration, and the field installation in the following chapters. This manual is intended for those people who will install and operate the AirEther BR108.

Table of contents

PREVIOUS HISTORY.....	2
PREFACE	3
TABLE OF CONTENTS.....	4
TABLE OF CONTENTS.....	6
MANUAL CONVENTIONS.....	7
DISCLAIMER.....	8
1. INTRODUCTION	9
2. AIRETHER BR108 HARDWARE FEATURE	10
2.1 HARDWARE ARCHITECTURE.....	ERROR! BOOKMARK NOT DEFINED.
2.2 PRODUCT FEATURE.....	10
2.3 PRODUCT AND ACCESSORIES	10
2.4 PRODUCT CONNECTION FEATURE	11
2.4.1 External Antenna & Power over Ethernet (PoE) Cable Connector.....	11
2.4.2 Grounding Screw	11
2.4.3 Caution over Cable Connection	11
2.5 PRODUCT WARRANTY	12
2.6 WARRANTY LIMITATION.....	12
2.7 REQUIREMENT	12
2.8 FEATURE SUMMARY	13
3. IP DISCOVER UTILITY.....	14
4. BRIDGE (AIRETHER BR108) CONFIGURATION	16
4.1 THE MASTER/SLAVE SIDE PC NETWORK CONFIGURATION	16
4.1.1 How To Start Network Configuration on your PC	16
4.1.2 Master Bridge side PC TCP/ IP Setup.....	17
4.1.2.1 Master side PC TCP/IP Setup.....	17
4.1.2.2 Master Bridge Side PC IP/ MAC Address Set up	17
4.1.2.3 Slave Side PC Configuration and TCP/IP set up.....	18
4.1.3 MASTER/SLAVE BRIDGE CONFIGURATION.....	19
4.1.3.1 How To Start	19
4.1.3.2 Master/Slave Bridge Configuration	20
4.1.3.2.1 After Login.....	20
4.1.3.2.2 Region/Country Set up	20
4.1.3.2.3 Master/ Slave side IP/ MAC Address first time Set up.....	22
4.1.3.2.3 Configure 5GHz Bridge Setting	23
Radio Setting	23
Security Setting – Master / Slave side Share/Unique Key	26
Master Side	27
Slave Side	28
4.1.4.2 Master & Slave Bridge joining condition	29
4.1.4.3 Statistics.....	29
4.2 FIRMWARE AND LICENSE UPGRADE.....	32
4.3 REBOOTING	33
5. SNMP.....	34
6. PLANNING LINKAGE.....	38
6.1 SITE SURVEY	38
6.2 DATA RATE.....	39
6.3 PLANNING RADIO PATH	39
6.3.1 Antenna Height	41
6.3.2 Antenna Types	42
6.3.3 Antenna Cable	42
6.3.4 Weather Affection.....	43
7 FIELD INSTALLATION.....	44

7.1 UNPACK THE SHIPMENT	44
7.1.1 <i>Required Tools:</i>	44
7.1.2 <i>Product</i>	44
7.1.3 <i>Accessories</i>	44
7.2 INSTALLING THE ODU.....	45
7.2.1 <i>Required Tools:</i>	45
7.2.2 <i>Installed Accessories:</i>	45
7.2.3 <i>How to Mount the Bridge:</i>	45
7.2.4 <i>Connecting the cable</i>	46
7.2.5 <i>General Antenna and Safety Tips</i>	46
7.2.6 <i>Basic Antenna Alignment</i>	47
7.2.7 <i>ESD Protection</i>	47
7.2.8 <i>Review the Installation</i>	47
APPENDIX A	48
GLOSSARY.....	48
APPENDIX B	50
TROUBLESHOOTING.....	50

Table of contents

Picture1 Bridge Architecture	Error! Bookmark not defined.
Picture 2 Bridge	11
Picture 3 Connection1	11
Picture 4 IP Discover Tool	14
Picture 5 Find out the IP and MAC address	15
Picture 6 Start Menu	16
Picture 7 Network Connection	16
Picture 8 Local Area Connection Properties	17
Picture 9 Internet Protocol Properties	18
Picture 10 Enter Username and Password	19
Picture 11 Statistic Page	20
Picture 12 Region/Country Setup	21
Picture 13 Manually setup IP address	22
Picture 14 Auto Get IP	23
Picture 15 5GHz Bridge (Master)	26
Picture 16 5GHz Bridge (Slave)	26
Picture 17 Master Bridge Security Setup	27
Picture 18 Slave Bridge Security	28
Picture 19 Master/Slave Bridges Connections	29
Picture 20 Statistics	30
Picture 21 Firmware Upload Web Page	32
Picture 22 Rebooting Window	33
Table 1 Evaluated Maximum Distance	39
Picture 23 Line-of-Sight (LOS)	40
Table 2 Estimated LOS Clearance	41
Picture 24 Antenna Height	41
Picture 25 The Bridge with the omnidirectional antenna	42
Picture 26 Mount the ODU on the Mask or the Pole	45

MANUAL CONVENTIONS

<i>Bold</i>	Bold type within paragraph text indicates commands, file names, directory names, paths, output, or returned values.
<i>Italic</i>	Within commands, italics indicate a variable that the user must specify. Titles of manuals or other published documents are also set in italics.
Courier	The courier font indicates output or display.
[]	Within commands, items enclosed in square brackets are optional parameters or values that the user can choose to specify or omit.
{}	Within commands, item enclosed in braces are options from which the user must choose.
	Within commands, the vertical bar separates options.
...	An ellipsis indicates a repetition of preceding parameter.
>	The right angle bracket separates successive menu selection.

NOTE: This message denotes neutral or positive information that calls out important points to the text. A note provides information that applies only in special cases.



Caution: Cautions call special attention to hazards that can cause system damage or data corruption, to a lesser degree than warnings.



Warnings: Warnings call special attention to hazards that can cause system damage, data corruption, personal injury, or death.

DISCLAIMER

AirEther BR108 Wireless Outdoor Bridge User Manual

Document No.: 50-5000(REV: 3.24), July. 14, 2006.

Any part of this publication could not be copied, stored in a retrieval system, or translated into any language or computer language in any form or any means, electronic, magnetic, chemical, manual or otherwise, without the prior written permission of our company.

The instructions in this manual have been carefully checked for accuracy and are presumed to be reliable. The accuracy and adequacy of this document are the responsibilities of our company. Please email any comments or corrections to our review team at review@inscapedata.com.

1. Introduction

The AirEther BR108 is designed for the outdoor environment. It will function under the strict weather as the following passages you see. About the further protection, the bridge and Power over Ethernet adapter are built with the lightning protector. This advanced innovation is to help you to increase from the productivity, cost-effective, mobile Internet access, to other sections.

The AirEther BR108 is a wireless building-to-building bridge solution. The AirEther BR108 provides the data rate up to 108 Mbps that is best suited for enterprises, campus or off-site locations that require LAN or Internet access without the availability of wired networks to extend the network coverage. The AirEther BR108 provides the point to point and point to multi-point connection.

One of the AirEther BR108 advanced feature is over the data rate section. The bridge has two data rate modes, one is the IEEE 802.11a, and another is the IEEE802.11a turbo. About the bridge under the IEEE 802.11a mode, it supports the data rate from 6 Mbps to 54 Mbps. Under the IEEE802.11a turbo mode, it supports the data rate from 12 Mbps to 108 Mbps in turbo mode. The supported frequency channel for the IEEE802.11a or the IEEE802.11a turbo are across from 5.15 to 5.85 GHz.

Another advanced design is the security setting. We all know the security is the major issue over the wireless communication. We offer the two modes on the security setting, one is “Shared Key”, and the other is “Unique Key”. It is really easy for you to secure your communication through this thoughtful feature.

About the field installation, it is easy for you to install the device outside field. The following paragraphs remind you what you need to notice during the installation form the site survey, antenna installation, to the ODU installation. We also offer you the evaluated max distance as your reference under the IEEE802.11a and the Antenna gain is either 17 dBi or 23 dBi.

During the appendix section, we offer you some terminologies explanation and how to do the simple troubleshooting when you encounter the difficult over the wireless connection.

2. AirEther BR108 Hardware FEATURE

2.1 Product Feature

- **Temperature** — The wireless bridge is tested for normal operation in temperatures from -30°C to 70°C.
- **Wind Velocity** — The wireless bridge can operate in winds up to 90 MPH and survive higher wind speeds up to 125 MPH. You must consider the known maximum wind velocity and direction at the site and be sure that any supporting structure, such as a pole, mast, or tower, is built to withstand this force.
- **Lightning** — The wireless bridge includes its own built-in lightning protection. However, you should make sure that the unit, any supporting structure, and cables are all properly grounded. Additional protection using lightning rods, lightning arrestors, or surge suppressors may also be employed.
- **Range** — The wireless bridge has been refined and optimized for long range application, up to 28Km under the Basic data mode, and 14Km at the Turbo mode.
- **Rain** — The wireless bridge is weatherproofed against rain and prolonged heavy rain has no significant effect on the radio signal. It is highly recommended to use sealing tape around the RF connector for prolonged operation. If moisture enters the connector, it may cause degradation in performance or even a complete failure of the link.

2.2 Product and Accessories

- A. AirEther BR108 high capacity outdoor bridge unit
- B. Ethernet Inline Power Injector (PoE), 48V, 1Amp, with Power Cord
- C. Weatherproof connector kit
- D. Installation CD with Locator Utility & User Manual CD
- E. Mast Mount U Bolt
- F. Warranty Information Sheet
- G. Quick Installation Guide

2.4 Product Connection Feature

2.4.1 External Antenna & Power over Ethernet (PoE) Cable Connector

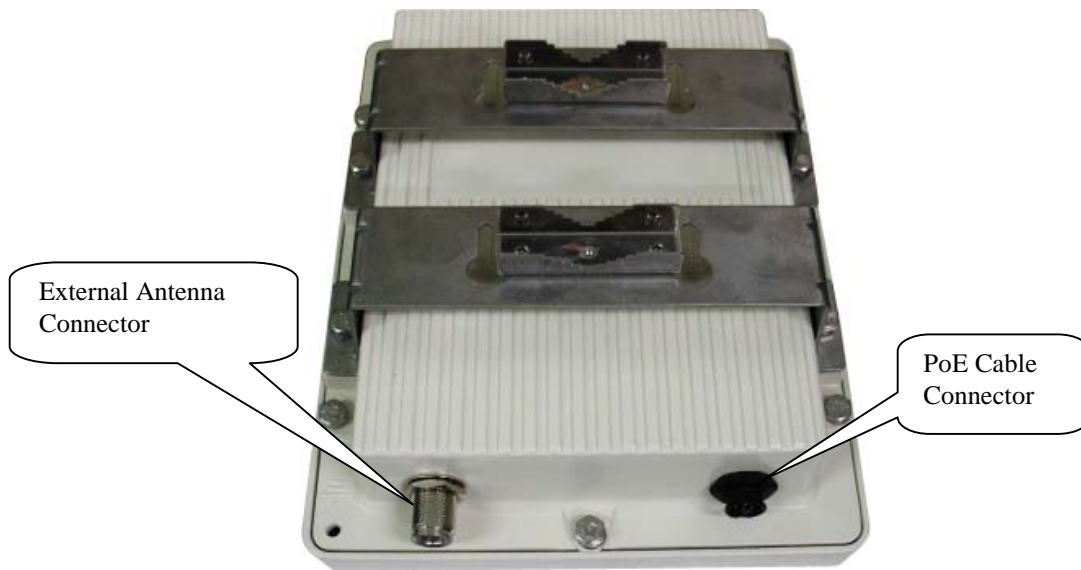

Picture 2 Bridge

2.4.2 Grounding Screw

- 1) Be grounding strip connection.
- 2) Proper grounding is always for the safety consideration.

2.4.3 CAUTION OVER CABLE CONNECTION

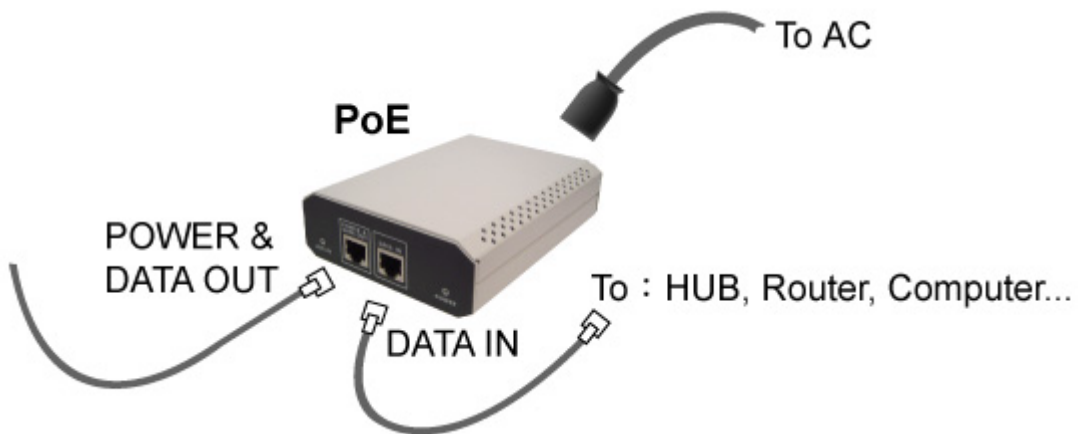

Picture 3 Connection1

2.5 Product Warranty

Our product is warranted against defects in materials and workmanship for a period of one year from date of shipment. During the warranty period time, we will either repair or replace products which to be defective.

For warranty service or repair, this product must be returned to a service facility designated by us. Buyer shall prepay shipping charges to us and we shall pay shipping charges to return the product to Buyer. However, buyers shall pay all shipping charges, duties, and taxes for products returned to us from another country.

Our warranty is for its software and we designed firmware when you properly installed on this product. We do not warrant that the operation of the product, or software, or firmware will be uninterrupted or error free.

2.6 Warranty Limitation

The foregoing warranty shall not apply to defects resulting from improper or inadequate maintenance by buyers, buyer-supplied software, interfacing, unauthorized modification, inappropriately use, operation out of the product environment specifications, or improper site preparation and maintenance.

No any other warranty is expressed or implied. We specifically disclaim the implied warranties of merchantability and fitness for a particular purpose.

2.7 Requirement

- An FTP server is required for update bridge firmware.
- The Ethernet connection is required for the initial Bridge configuration.

2.8 Feature Summary

- Provide the Ethernet to Wireless LAN Bridge fully compatible on IEEE 802.3 Ethernet side and fully interoperable with IEEE 802.11a compliant equipments.
- The Ethernet interface with 10 /100Base-T.
- The operating mode is for IEEE 802.11a infrastructure.
- The dynamic data rate switching with 6, 9, 12, 18, 24, 36, 48, 54 and turbo mode allows auto fallback data rate for optimized reliability, throughput and transmission range.
- Using the FTP to upgrade the Firmware.
- The 17dBi directional flat panel antenna offers up to 20 km transmission range with the 6MHz data rate.
- The lightning protector.
- Outdoor environment.

3. IP Discover Utility

A simple Windows Utility is supplied on the CD. This utility can be used to locate the IP address of the AirEther BR108 Outdoor Bridge on the same sub-network segment. Although the AirEther BR108 Outdoor Bridge has a default IP address, this utility is useful when the network administrator forgets the modified IP address. Before using this utility, please make sure the system firewall installed in your PC is “Disable”.

Below the installation and usage procedure:

1. Insert the Utility and User's Manual CD into the CD-ROM drive.
2. Once the menu screen appears, click on the “IP Discover Tool” for installation. If the menu screen does not appear, enter E:\Utility\setup.exe (Assume “E” is your CD-ROM drive). Follow the prompts to complete the installation.
3. After the installation completes, you can start this utility from “Start”>”Program Files”>”IpDiscover1.1”>”IpDiscover1.1”.
4. Once the utility is executed, the below screen will pop up. The “Interface(IP)” shows the current IP address of your computer.

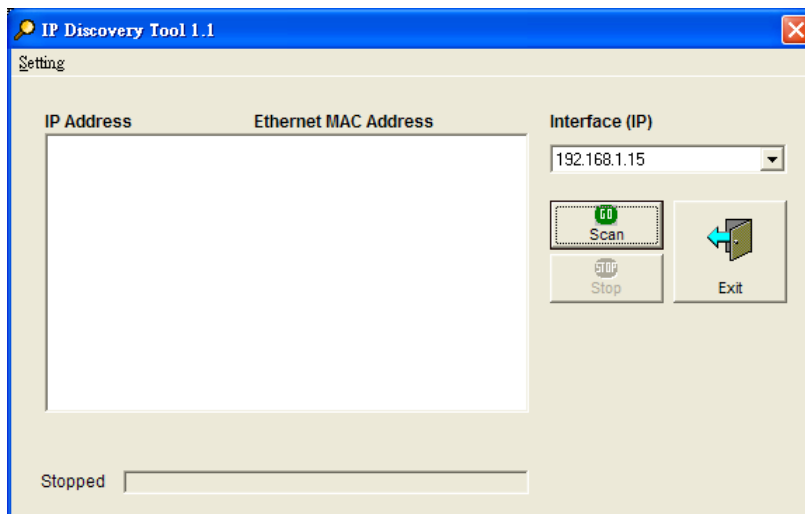

Picture 4 IP Discover Tool

5. Click on the “Scan” button for the utility to start searching. And the utility will display the IP address and MAC address of the available AirEther BR108 Outdoor Bridge. Now you can using a web browser to access the management interface with the IP address.

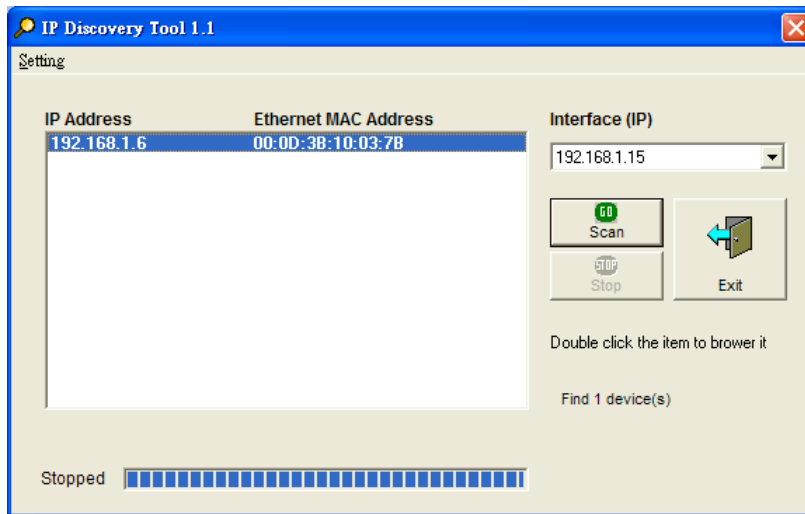

Picture 5 Find out the IP and MAC address

4. Bridge (AirEther BR108) Configuration

4.1 The Master/Slave side PC Network Configuration

4.1.1 How To Start Network Configuration on your PC

- 1) Click the “**Start Menu**” and choose “**Setting**”.
- 2) Click “**Network and Dial-up Connection**”.
- 3) Right-click on the “**Local Area Connection**” and select “**properties**”.

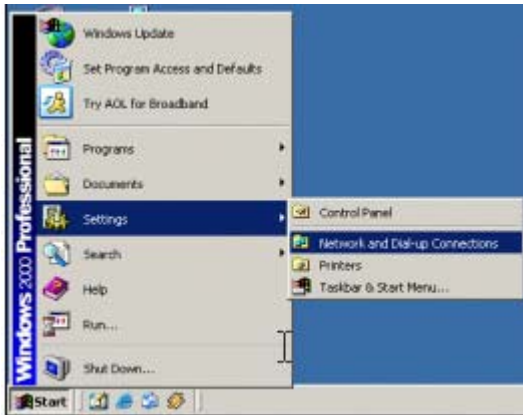

Picture 6 Start Menu

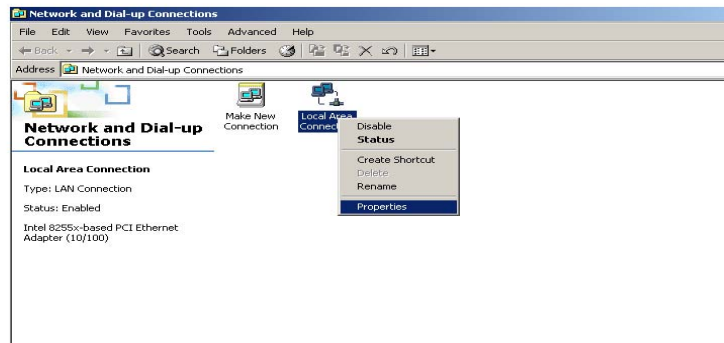

Picture 7 Network Connection

4.1.2 Master Bridge side PC TCP/ IP Setup

4.1.2.1 Master side PC TCP/IP Setup

- 1) After clicking on **“Property”**, you will see the diagram as below.
- 2) Marking the **“Internet Protocol (TCP/IP)”** and click the **“Properties”**

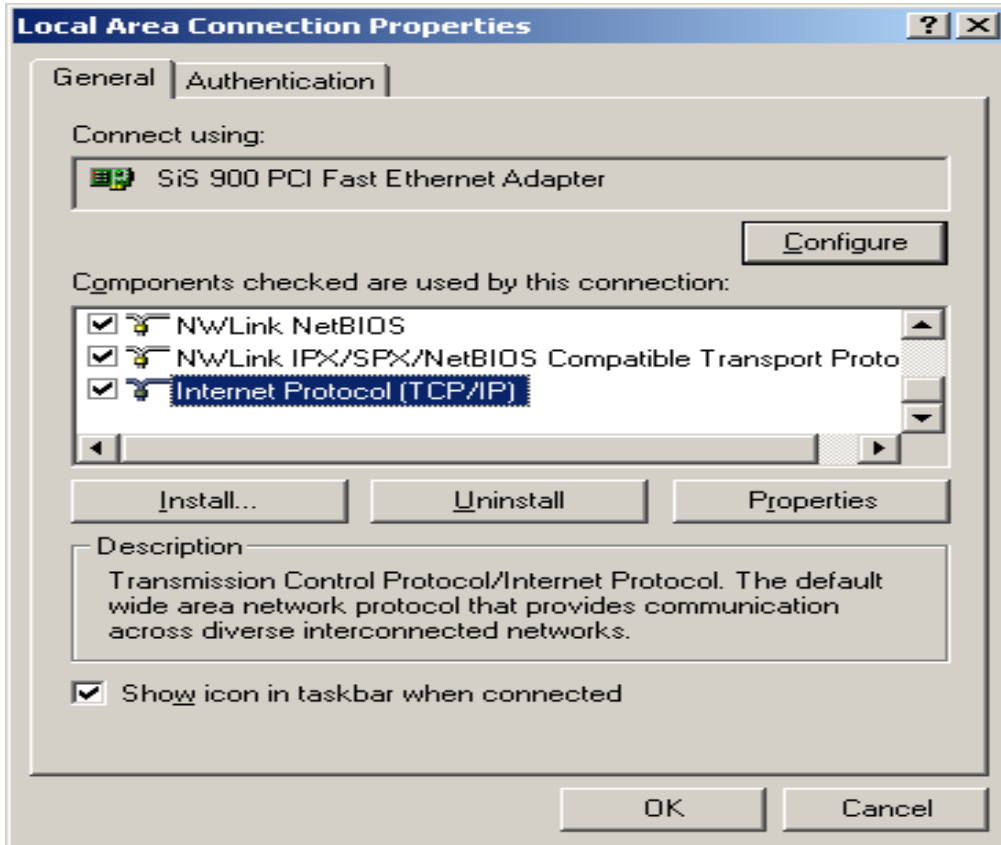

Picture 8 Local Area Connection Properties

4.1.2.2 Master Bridge Side PC IP/ MAC Address Set up

- 1) Use **“IP address (ex. 192.168.1.2)”** under the same Bridge subnet and **Bridge Default IP Address(192.168.1.20)**.
- 2) Using the default Subnet Mask Setting During the first time.
(**Default value: 255.255.255.0**)
- 3) Keep the **“Default Gateway”** as **“Blank”**.
- 4) Keep the **“DNS Server Address”** as **“Blank”** also.
- 5) Click **“OK”** when you finish setting and Close the Window.

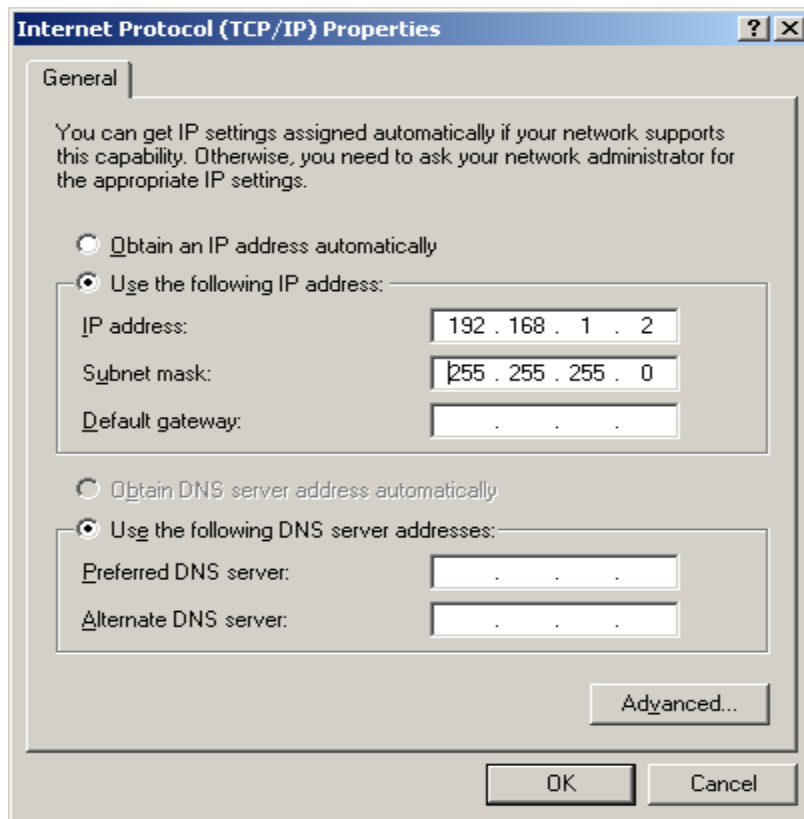

Picture 9 Internet Protocol Properties

4.1.2.3 Slave Side PC Configuration and TCP/IP set up

- 1) About “ **the Slave side PC Configuration** “, you just follow “**the same Set up method**” as how you set the Master side.
- 2) As **TCP/IP**, you also follow “**the exact same procedure**” as you set up the Master side PC.

4.1.3 Master/Slave Bridge Configuration

4.1.3.1 How To Start

- 1) Launch a Web Browser.
- 2) Key in **the default IP Address as URL** (Default IP Address is http:// **192.168.1.20**).
- 3) **“Enter Network Password”** Diagram will appear.
- 4) Enter **“Username: Admin”**(Case Sensitive).
- 5) Enter **“Password: 5up”** (Case Sensitive).
- 6) Click **“OK”** when you finish.

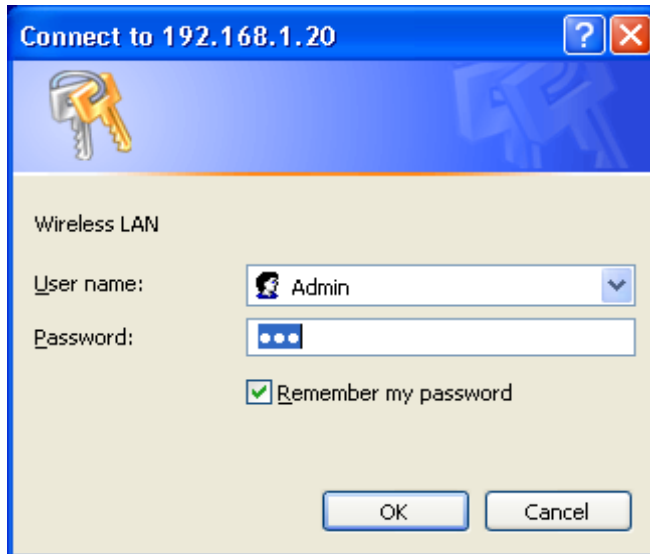

Picture 10 Enter Username and Password

4.1.3.2 Master/Slave Bridge Configuration

4.1.3.2.1 After Login

You will access by clicking the “**Management**” from left side menu.

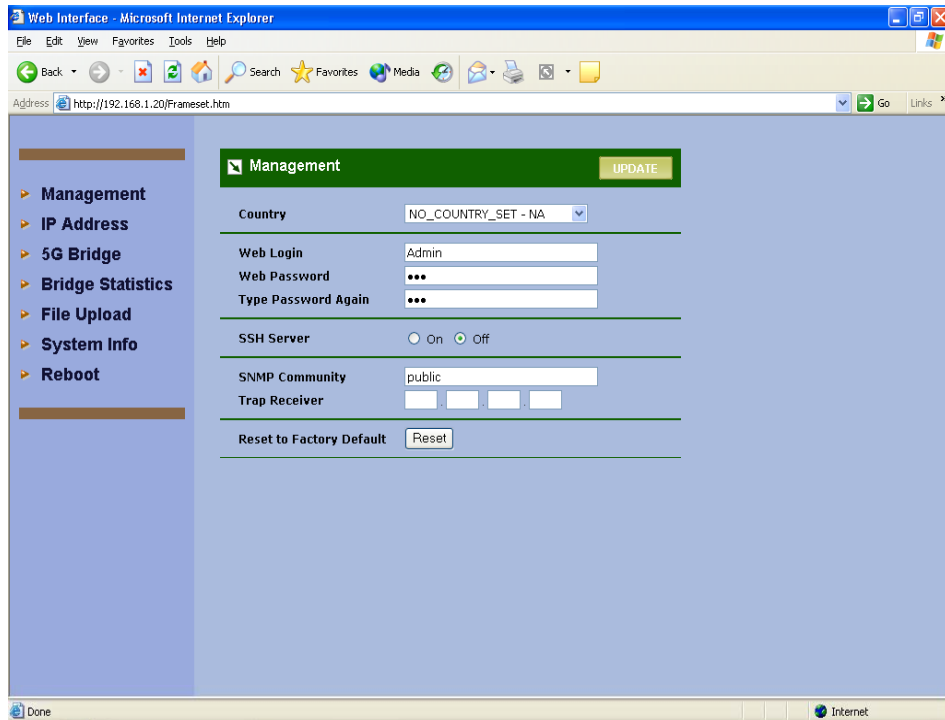

Picture 11 Statistic Page

4.1.3.2.2 Region/Country Set up

- 1) Click the “**Management**” on the left side of the Web page.
- 2) Select the “**Country**” you want from the list. Why you need to select the “**Country or Region**” is because “**different countries have its own RF regulation**”.
- 3) You need to use “**the default Username and Password**” when you sign in for the first time.
- 4) **SSH Server** SSH is a secured telnet-like mechanism to invoke the command line interface. All the commands and response will be encrypted. SSH function can *co-exist with Telnet function*. The SSH port is 22. You need to have an SSH client (e.g. *OpenSSL*) to access SSH.



Note: The web browser needs to equip 128-bit Cipher Strength to process HTTPS SSL encryption. So, it is strongly recommended you use the web browser whose version newer than or equal to IE (Internet Explorer) 6 SP1 or Netscape 7. Otherwise, you might experience the response of "The Page Cannot Be Displayed".

- 5) **SNMP Community** Community name is a string for administrator to read the SNMP MIB from external SNMP manager. The default SNMP community

name is “public”. You may change the community name here as your plan.

- 6) **Trap Receiver** Trap is the notification of certain events generated by SNMP agent to send to the network management server. To have the Outdoor WLAN product send SNMP trap, you need to enter the IP address of the server where the trap is sent to. There are two trap messages, "**Cold Start**" and "**Link Up**", are supported. They are sent out when the system is started.
- 7) **Reset to Factory Default** Press this button to reset to factory default.
- 8) Click  and “**Reboot**” when you finish setting up.

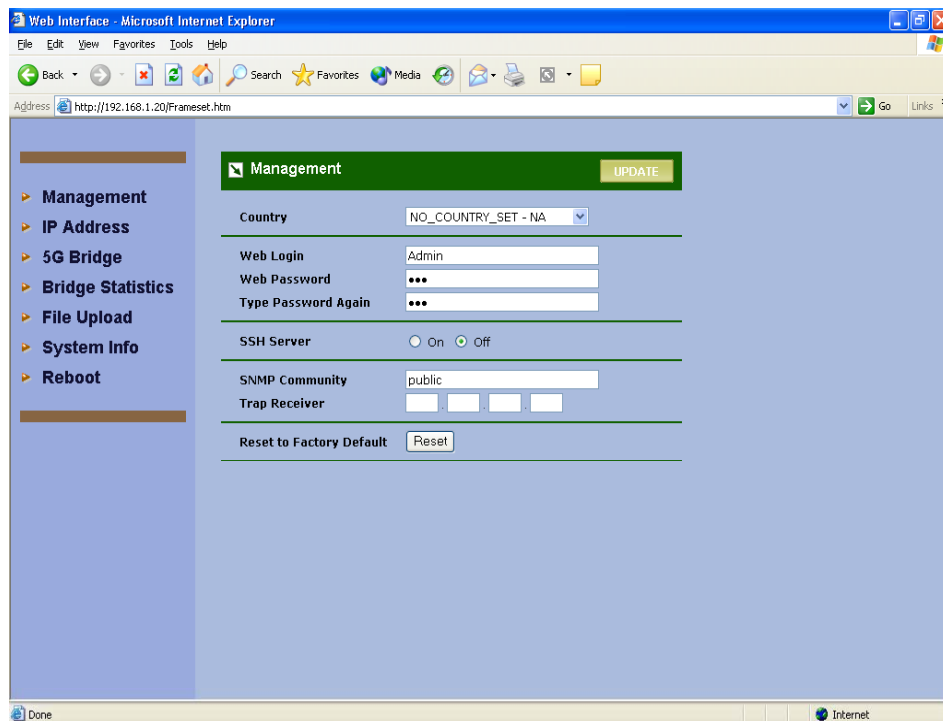

Picture 12 Region/Country Setup

4.1.3.2.3 Master/ Slave side IP/ MAC Address first time Set up

- 1) “ **Bridge Default IP Address (192.168.1.20)** ” to do the first time set up and you could change the IP Address you have after signing.
- 2) “**Default value (255.255.255.0)**” for the first time set up.
- 3) Keep the “**Default Gateway**” as “**Blank**” or set it up if you have your own “**Default Gateway**”.

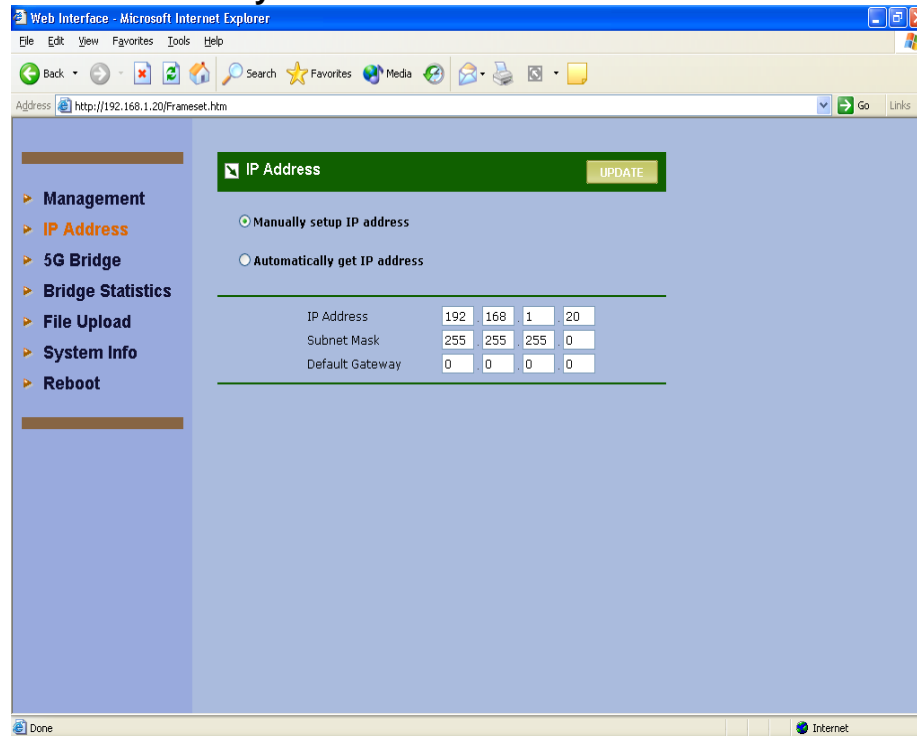

Picture 13 Manually setup IP address



Note: that every radio in the same network must be assigned a unique IP address. So, you may need to have a network plan before deployment. Enter the IP address, Subnet Mask and Gateway Address according to the planning. If there is no gateway in the network, you may leave it all zeros.

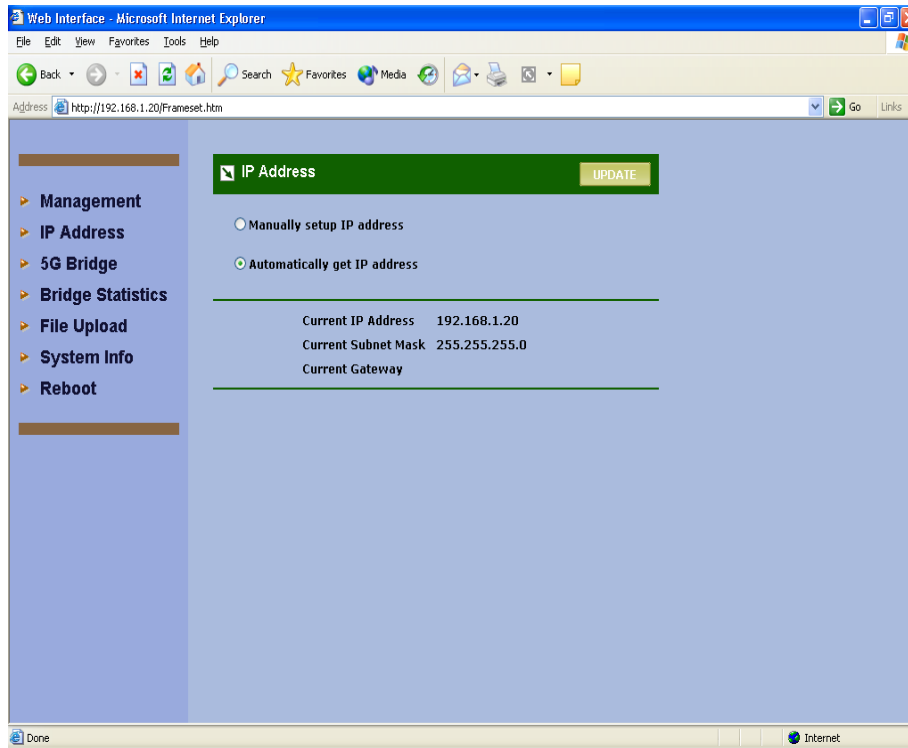

Picture 14 Auto Get IP

This will get the IP address from DHCP server if you have DHCP server enable in your subnet.

4.1.3.2.3 Configure 5GHz Bridge Setting

Radio Setting

- 1) **Bridge Type** If the application is only for “*Point to Point*” architecture, the set it as **Slave** one on each side. If the intended configuration is for “*Point to Multipoint*” network architecture, you need one bridge loaded with **Master Bridge** as host to wireless connect with the multiple remote bridges loaded with **Slave Bridge(s)**.
- 2) **Remote Bridge MAC Address** In order to establish the wireless link between bridge radios, the MAC address of remotes bridge(s) need to be registered in the address table. Type the MAC address with format xx:xx:xx:xx:xx:xx (x is the hexadecimal digit) and use “Add” and “Delete” button to edit the address table. A Master Bridge Radio may accommodate *up to 4* remote MAC addresses.
- 3) **Bridge Security** Please refer to “Bridge Security Setting” in the next section.
- 4) **Wireless Mode** There is two modes provided: 54Mbps (802.11a) and 108Mbps (802.11a Turbo). The mode of 108Mbps offers the double data rate than of 54Mbps.
- 5) **Channel** Select a radio channel according to the availability or system plan. It is required for Bridges having the same radio frequency to communicate each other. “**SmartSelect**” is **NOT** recommended for the bridge applications.
- 6) **Data Rate** Available data rate range is dependent on the selection of Wireless Mode in 5GHz Radio Basic Setting page. Rates of 6, 9, 12, 18, 24, 36, 48

and 54Mbps are supported for the wireless mode of 54Mbps (802.11a). And, rates of 12, 18, 24, 36, 48, 72, and 108Mbps are supported for the wireless mode of 108Mbps (802.11a Turbo). The mode of 108Mbps offers the double data rate than of 54Mbps.



Note: In order to maximize the system performance, it is recommended to follow the following suggestions.

- ◆ For **Master Bridge**, it is recommended to set data rate into “best” on Master Bridge to communicate with Slave Bridges of different distance and signal strength.
- ◆ For **Slave Bridge**, it is recommended to check or predict the received signal strength at the Slave Bridge, and pick a supported data rate according to the following table. **Note: 3 to 5dB** additional margin is recommended to maintain a reliable link.

Modulation	Basic Mode		Turbo Mode	
	Data Rate (Mbps)	Minimum RX Sensitivity	Data Rate (Mbps)	Minimum RX Sensitivity
BPSK	6	-88	12	-85
BPSK	9	-87	18	-84
QPSK	12	-86	24	-83
QPSK	18	-84	36	-81
16QAM	24	-81	48	-78
16QAM	36	-76	72	-73
64QAM	48	-72	96	-69
64QAM	54	-68	108	-65

Table 1 5GHz RX Sensitivity VS. Data Rate

- 7) **Transmit Power** Available selection of Transmit Power are Full, Half (-3dB), Quarter (-6dB), Eighth (-9dB), and Minimum. Select the appropriate Transmit Power according to the distance and environmental factor between Bridges.
- 8) **RTS/CTS Threshold** In order to prevent the transmission collision in a hidden nodes environment, Bridge may send a RTS (Request To Send) before

transmitting the data frame and expect to receive a CTS (Clear To Send) from remote Bridge. You may define a threshold for those frame size greater than the threshold need to activate RTS/CTS mechanism. The valid range is between 256 and 2346. Set low value to this threshold may avoid collision, but the RTS/CTS frame would consume bandwidth.

- 9) **Distance** Setup “Bridge Distance” according to the longest link distance between the Master and Slaves in the network. The input needs to be greater than or equal to the real distance. The range can be from 1KM to 28KM.
- 10) **Super Bridge Mode** Super Bridge Mode provides three mechanisms to improve the bridge throughput.
 - ◆ **Compression:** Frame is compressed by hardware before transmitting. Note that the compression may save bandwidth but would consume frame process time. In case the data is already compressed (eg. mpeg frame), please do NOT turn on this function.
 - ◆ **Bursting:** Turning on Bursting function enables multiple frames are transmitted at SIFS intervals which may reduce transmission overhead. But this may increase packet error rate on the other side.
 - ◆ **Fast Frame:** Turning on Fast Frame function enables two Ethernet frames bundled into a single wireless frame.



Warning 1: It is required to setup the same options of Super Bridge Mode between Bridges to communicate.



Warning 2: It very depends on the deployed site environment to decide whether turning on Bursting & Fast Frame function or not.

- 11) **Auto Reboot** With this function enabled, Bridge will reboot itself automatically while there is no data received for 30 seconds. This function is disabled by default.
- 12) **Spanning Tree Protocol** This function is to prevent the network loop and disabled by default. It is suggested you enable this function when the network configuration is complicated.
- 13) Click  and “**Reboot**” the system after setting.

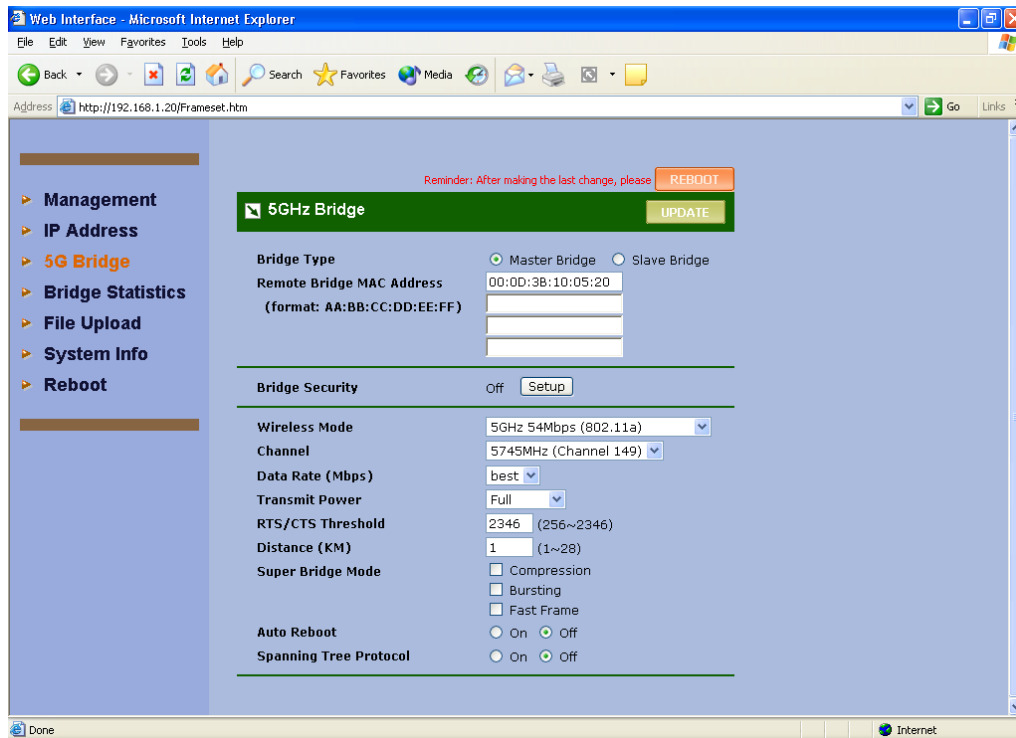

Picture 15 5GHz Bridge (Master)

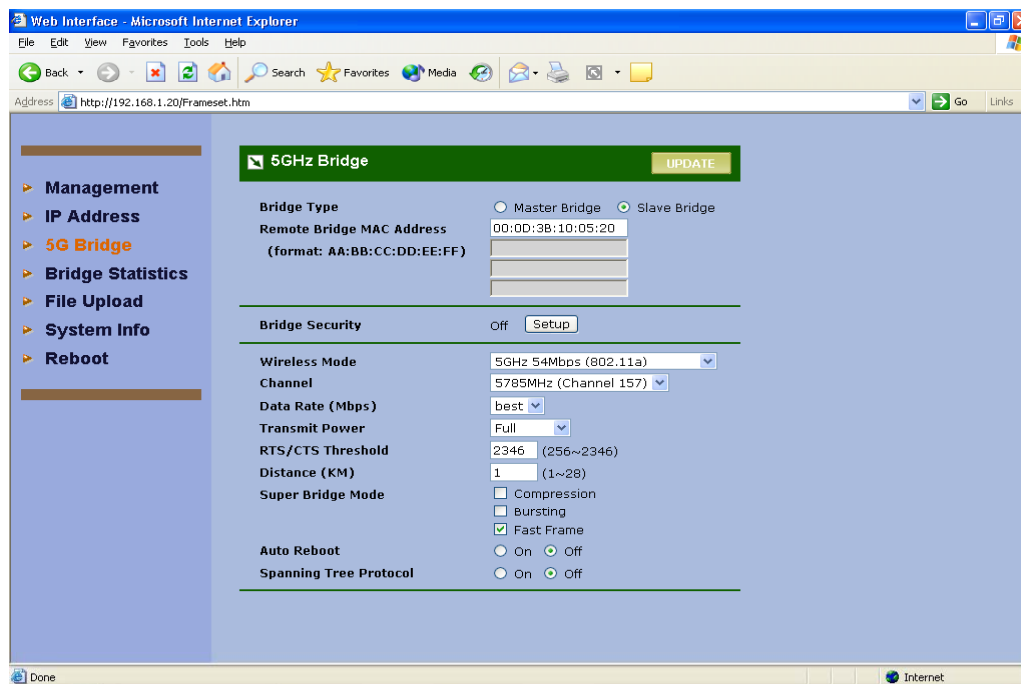

Picture 16 5GHz Bridge (Slave)

Security Setting – Master / Slave side Share/Unique Key

To have a secured data transmission, Outdoor WLAN Product provides 3 encryption mechanisms.

- ◆ 64-bit WEP (10 Hex. Digits/ 5 ASCII Keys)
- ◆ 128-bit WEP (26 Hex. Digits/ 13 ASCII Keys)
- ◆ 152-bit WEP (32 Hex. Digits/ 16 ASCII Keys)

The key entry method can be in either “Hexadecimal” or “ASCII Text”. The security setting between Master and Slave Bridge are different.



Note: It is required to have the same security setting between Bridges to communicate.

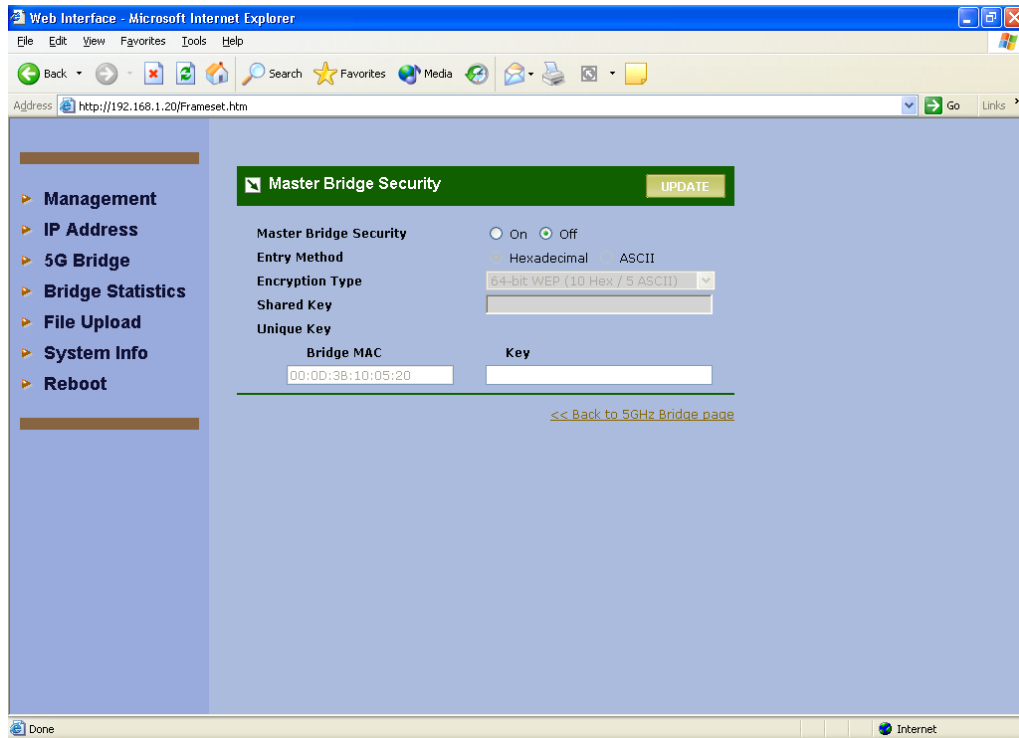

Picture 17 Master Bridge Security Setup

- 1) **Master Bridge Security**
Enable/Disable bridge’s security setting.
- 2) **Entry Method**
Hexadecimal -- The key input must be hexadecimal (0-9, A-F).
ASCII Text -- The key input can be any character.
- 3) **Encryption Type**
The encryption mechanism can be 64/128/152 “WEP”.

Master Side

A. Share Key – Hexadecimal / ASCII Mode

When **Share Key** is set, all Master-Slave links use this key to encrypt except the link(s) specified with Unique Key. To setup **Share Key**, please input “Entry Method” and “Encryption Type” first.

B. Unique Key

In some special applications, you may need to assign different key for each Master-Slave link instead of the same key for all links. It can be done by setting up **Unique Key per MAC address of Slave Bridge**.



Note: It is required to have the same security setting between linked Bridges to communicate.

Slave Side

Slave Bridge security setting may apply on bridges of “**Point-to-Point**” network as well as “**Point-to-Multipoint**” network.

For a “**Point-to-Point**” bridging network, 2 bridges to communicate each other need to use the same key of same encryption type.

For a “**Point-to-Multipoint**” bridging network, the key and encryption type **need to be** the same with **Unique Key** setting assigned to this **Slave Bridge**. Or, if there is no corresponding **Unique Key** being assigned on **Master Bridge**, then **Slave Bridge** should follow the **Share Key** assigned on **Master Bridge**.

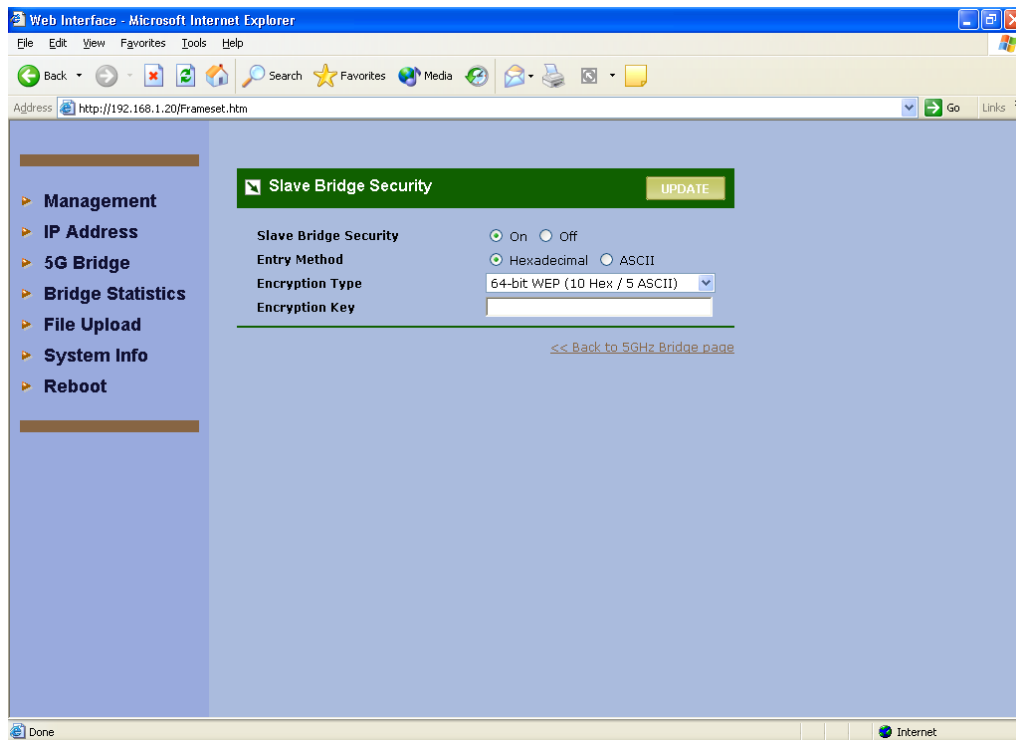

Picture 18 Slave Bridge Security

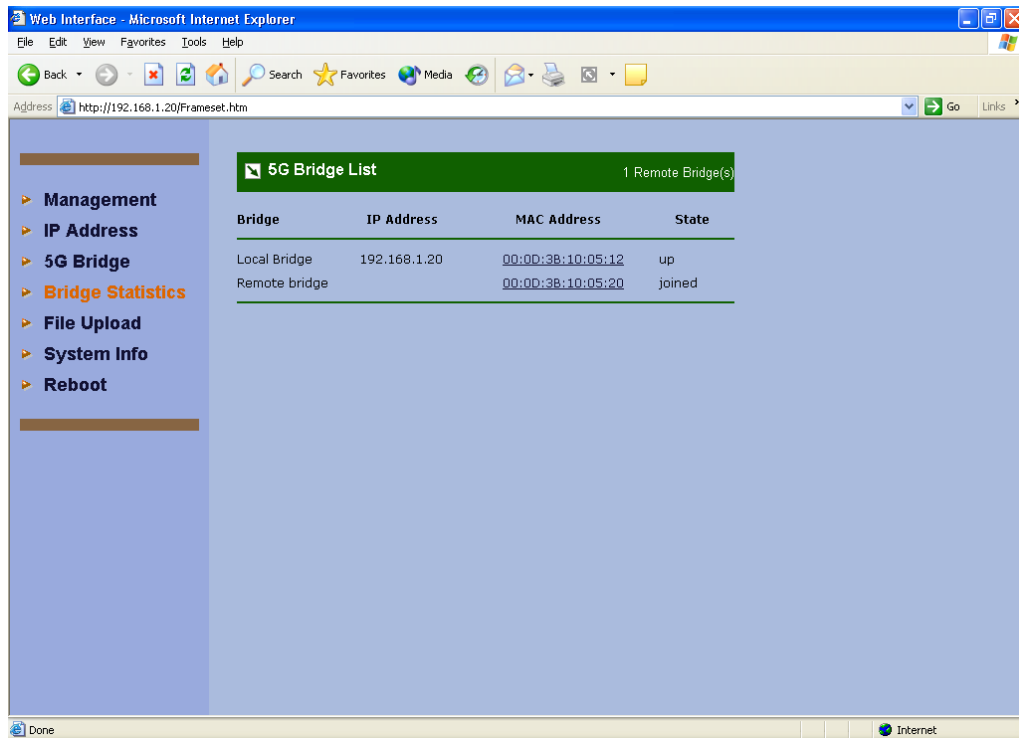

Picture 19 Master/Slave Bridges Connections

4.1.4.2 Master & Slave Bridge joining condition

- 1) **Local Bridge** This line shows the IP and MAC address of local Bridge as well as its state.
- 2) **Remote Bridge** This line shows the IP and MAC address of remote Bridge as well as its state.

4.1.4.3 Statistics

Clicking MAC address hyperlink of desired remote Bridge, system will show a Statistics page for you to monitor the information of the bridge link.

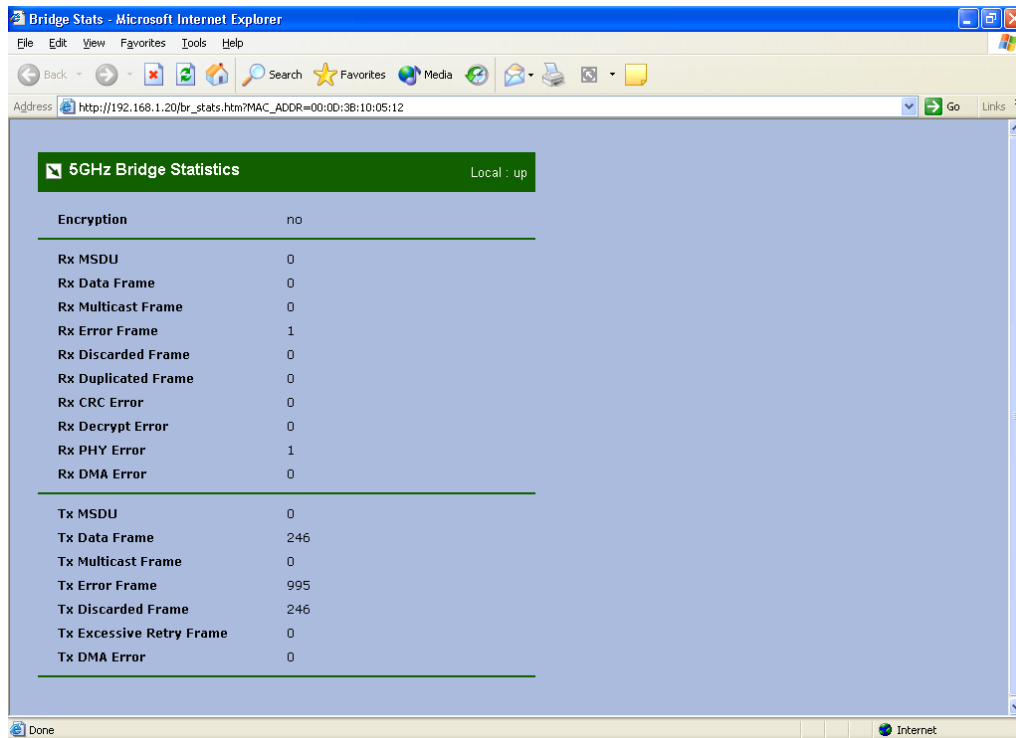

Picture 20 Statistics

Values on this page are automatically refreshed every **minute**. You may manually press the refresh button of browser to get the updated data more frequent. As RF signal strength is more critical for outdoor deployment purpose, **RSSI** bar is refreshed every **2** seconds.



Note: Due to frequent refresh of Statistics page, it is strongly recommended that you close this page when performing network performance tests.

Field	Description
RSSI	Displays the strength of the received signal in dBm (the remote bridge received signal strength). Refresh every 2 seconds.
RSSI of ACK	Displays the strength of the far end received signals in dBm (the local bridge received signal strength). Refresh every 2 seconds.
MSDU	Maximum service data unit. Displays the number of packets sent and received by the remote bridge.
Data / Management / Control	Packets can be data, management or control. Displays the number of packets sent and received for each.
Multicast	Displays the number of multicast frames.
Errors	Displays the error count for both transmit and receive.
Data Rate	Displays the receive and transmit data rate in Mbps.
Receive Errors	Displays the number of receive errors.
Discarded Frames	Displays the number of receive discarded frames.
Duplicate Frames	Displays the number of receive duplicate frames.
CRC Errors	Displays the number of receive CRC errors.
Decrypt Errors	Displays the number of receive decryption errors.
PHY Errors	Displays the number of receive PHY errors.
DMA Errors	Displays the number of receive DMA errors.
Transmit Errors	Displays the number of transmit errors.
Discarded Frames	Displays the number of transmit discarded frames.
Excessive Retries	Displays the number of transmit excessive retries.
DMA Errors	Displays the number of transmit DMA errors.

4.2 Firmware and License Upgrade

- 1) Firmware upgrade is for you to upgrade your bridges when the upgrade files release.
- 2) “ **Browse**” the firmware files to be uploaded from the Disc in the Picture 20 then click “ Upload and Update ” when you finish.
- 3) When uploading successful, users need to reboot the system by clicking “ **Reboot** ” on the left side column of the firmware upload page to make it effective.
- 4) Caution over the traffic on the bridge would be interrupted during system rebooting.

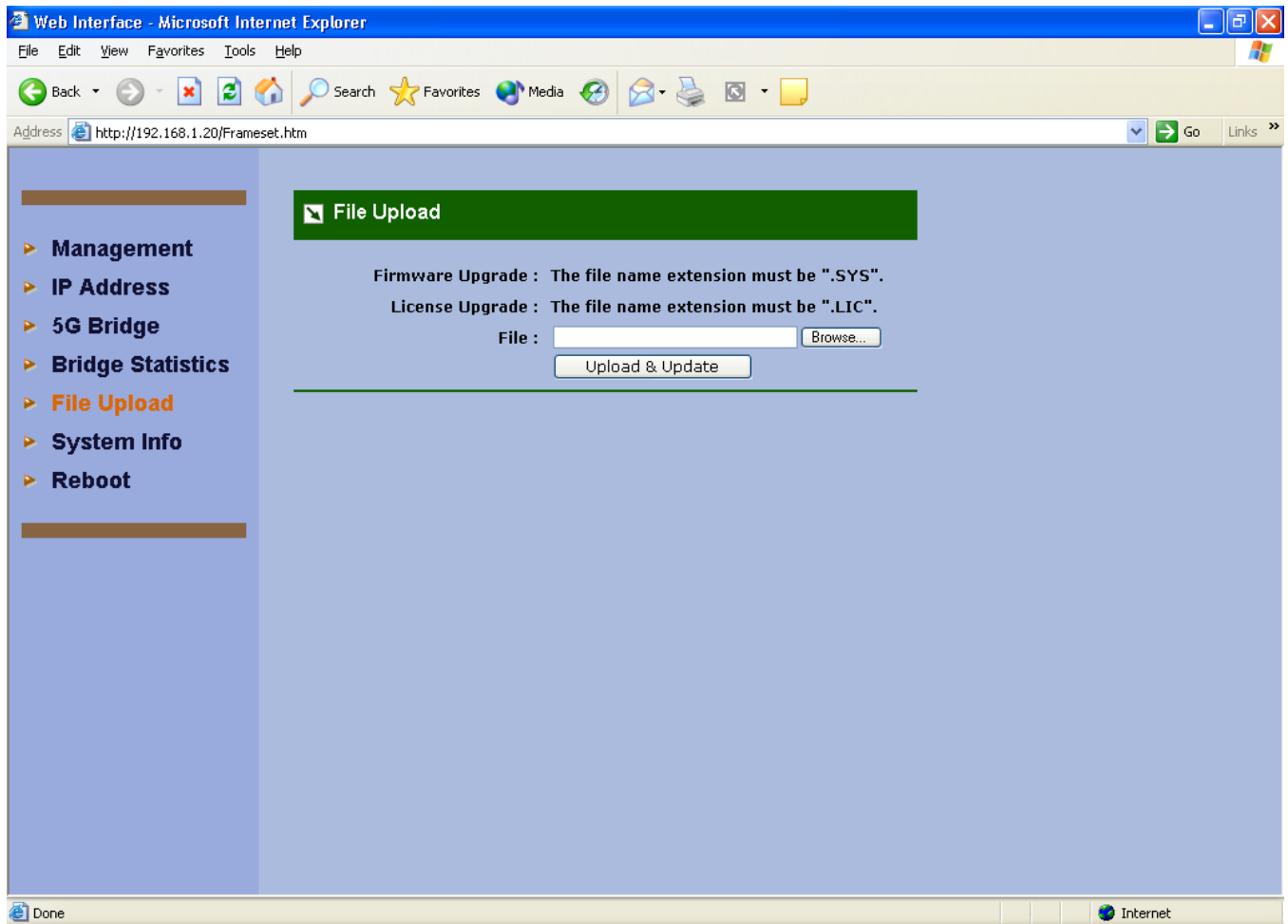

Picture 21 Firmware Upload Web Page



Note: In case network interruption happens during firmware uploading, system will still keep on current active firmware. You may perform the firmware upgrade again when network is back to normal.

4.3 Rebooting

- 1) Click **Update** and “**Reboot**” either “**each time**” or “**reboot**” the system once when you finish all kinds of settings.

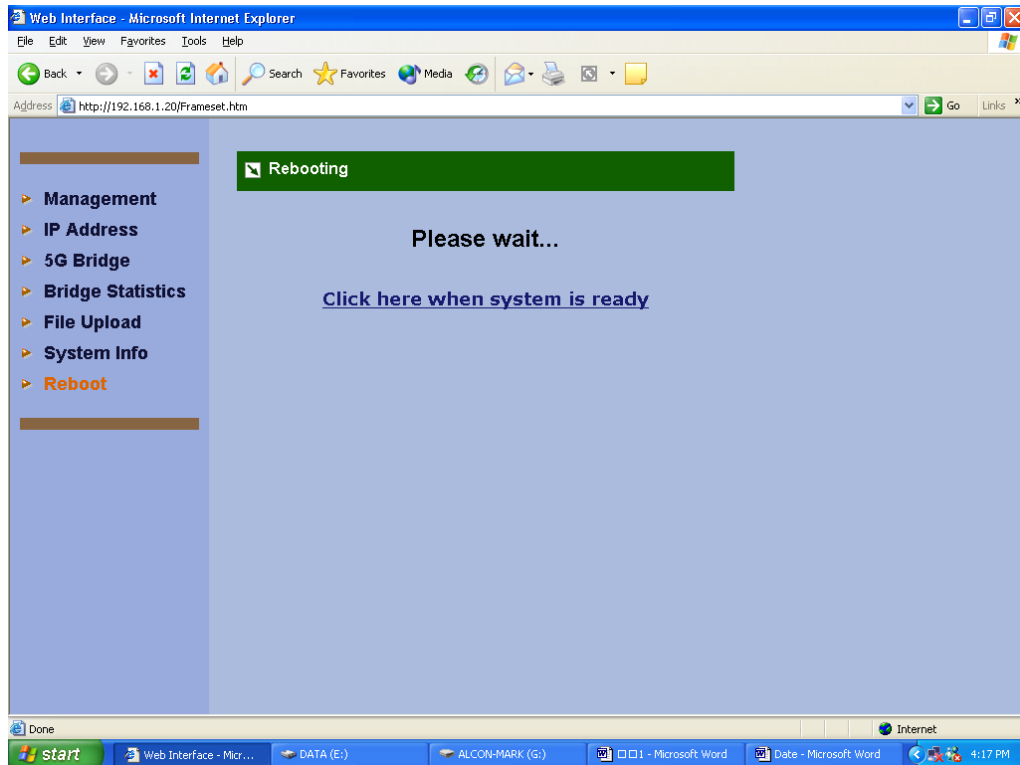

Picture 22 Rebooting Window

When all the parameters have been setup according to the network configuration and requirements, click “Update” and “Reboot” for parameter changes taking effect. When starting reboot, system will prompt you a rebooting window. It usually takes at least 30 seconds to finish the reboot process.

5. SNMP

The system provides SNMP v2c read capability for the network management. SNMP interface can be reached both locally and remotely.

The supported standard MIB including

- ◆ System of MIB-II
- ◆ Interfaces of MIB-II
- ◆ Address Translation of MIB-II
- ◆ IP of MIB-II
- ◆ ICMP of MIB-II
- ◆ SNMP of MIB-II

Besides, the enterprise MIB is also provided especially for Bridge management. The OID prefix is “1.3.6.4.1.9442.1.3”. OID field in the following table is shortened by specifying only the digits after prefix.

OID	MIB Name	Type	Description
.1.1.1	dot11StationID	string	Wireless MAC address of system
.1.1.2	dot11DesiredSSID	string	The value shall be the same as SSID of system itself.
.1.1.3	dot11DesiredBSSType	int	The value shall be 1. 1: Infrastructure; 2: Independent; 3: Any
.1.1.4	dot11BeaconPeriod	int	The number of TU that shall use for scheduling Beacon transmissions.
.1.1.5	dot11DTIMPeriod	int	The number of beacon intervals that shall elapse between transmission of Beacons frames containing a TIM element whose DTIM Count field is 0.
.1.1.6	dot11PrivacyOptionImplemented	int	This value is 1 if WEP is implemented.
.1.1.7	dot11OperationalRateSet	string	This string contains 16 '0's.
.1.1.8	dot11AuthenticationAlgorithm	int	1: Open system; 2: Share key
.1.1.9	N/A		
.1.1.10	N/A		
.1.1.11	dot11CountryString	string	Identify the country the system is operating.

.1.2.1	dot11DisassociateReason	int	
.1.2.2	dot11DisassociateStation	string	
.1.2.3	dot11DeauthenticateReason	int	
.1.2.4	dot11DeauthenticateStation	string	
.1.2.5	dot11AuthenticateFailStatus	int	
.1.2.6	dot11AuthenticateFailStation	string	
.1.3.1	dot11PrivacyInvoked	int	When this attribute is true, it shall indicate that the IEEE 802.11 WEP mechanism is used for transmitting frames of type Data.
.1.3.2	dot11WEPDefaultKeyID	int	This attribute shall indicate the use of the first, second, third, or fourth element of the WEPDefaultKeys array when set to values of zero, one, two, or three.
.1.3.3	dot11WEPKeyMappingLen	int	The maximum number of tuples that dot11WEPKeyMappings can hold.
.1.3.4	dot11ExcludeUnencrypted	int	
.1.3.5	dot11WEPICVErrorCount	counter	This counter shall increment when a frame is received with the WEP subfield of the Frame Control field set to one and the value of the ICV as received in the frame does not match the ICV value that is calculated for the contents of the received frame.
.1.3.6	dot11WEPExcludedCount	counter	
2.1.1	dot11MACAddress	string	Wireless MAC address of system
2.1.2	dot11ManufacturerID	string	Value is "Micorelectronics Technology Inc."
2.1.3	dot11ProductID	string	Value is "BR5811"
2.1.4	dot11ResourceTypeIDName	string	Value is "RTID"
2.2.1	dot11RTSThreshold	int	
2.2.2	dot11SwTxRetryLimit	int	
2.2.3	dot11HwTxRetryLimit	int	
2.2.4	dot11FragmentationThreshold	int	
2.2.5	dot11MaxTxMSDULifetime	int	This value is 512

2.2.6	dot11MaxRxLifetime	int	This value is 512
2.3.1	dot11TxFragmentCount	counter	=Tx MSDU on statistics web
2.3.2	dot11MulticastTxFrameCount	counter	=web's Multicast-Broadcast on statistics web
2.3.3	dot11FailedCount	counter	=TxError on statistics web
2.3.4	dot11RetryCount	counter	=Excessive Retries on statistics web
2.3.5	dot11MultipleRetryCount	counter	
2.3.6	dot11FrameDuplicateCount	counter	=Duplicated Frame on statistics web
2.3.7	dot11RTSSuccessCount	counter	
2.3.8	dot11RTSFailureCount	counter	
2.3.9	dot11ACKFailureCount	counter	
2.3.10	dot11RxFragmentCount	counter	=Rx MSDU on statistics web
2.3.11	dot11MulticastRxFrameCount	counter	
2.3.12	dot11CRCErrorCount	counter	
2.3.13	dot11TxFrameCount	counter	=Tx MSDU on statistics web
2.3.14	dot11WEPUndecryptableCount	counter	
3.1.1.1	RemoteBridgePhysAddr	string	The MAC address of remote bridges.
3.1.1.2	RxRssiDbm	string	The receiving RSSI in the unit of dBm. If there is no signal, the value is "--".
3.1.1.3	TxRssiDbm	string	The transmission RSSI in the unit of dBm. If there is no signal, the value is "--".
3.1.2	BridgeDescr	string	The description of local Bridge.
3.1.3	Distance	int	The distance set between local and remote Bridges.
3.1.4	TxPower	int	full (0); half (1); quarter (2); eighth (3); min (4)
3.1.5	AutoReboot	int	enable (1); disable (0)
3.1.6	RssiAuxOutput	int	enable (1); disable (0)
3.2.1	dot11CurrentChannel	int	Current channel the system is using.
3.2.2	dot11CurrentTxRate	int	Current transmission rate in the unit of Kbps.

3.2.3	dot11TurboModeEnabled	int	enable (1); disable (0)
-------	-----------------------	-----	-------------------------

6. Planning Linkage

6.1 Site Survey

You need to consider the following operating and environmental conditions when performing a site survey:

- **Data rates** – The sensitivity and the radio range are inversely proportional to data rates. Therefore, the maximum radio range is achieved at the lowest workable data rate, and a decrease in receiver threshold sensitivity occurs as the radio data rate increases.
- **Antenna type and placement** - Proper antenna configuration is a critical factor in maximizing radio range. As a general rule, the radio range increases in proportion to antenna gain and height.
- **Physical environment** - Clear or open areas provide better radio range than closed or filled areas. Clear line of sight (LOS) is required to establish a good and reliable wireless link.
- **Obstructions** - Metal shelving or a steel pillar can hinder devices. To avoid placing these devices in locations where those obstructions are between the sending and receiving antennas.

6.2 Data Rate

According to the following table, you will have the idea about over what range the AirEther BR108 with what kind of antenna could operate under what data rate. You might also know the relationship between the data rate and the maximum radio range; for example, the bridge with 17dBi antenna could operate well under 6 Mbps data rate within 17 KM.

Data Rate	Maximum Distance (17dBi Antenna)	Maximum Distance (23dBi Antenna)
6 Mbps	17.72 KM	30.79KM
9 Mbps	16.82KM	29.36 KM
12 Mbps	16.07KM	28.07 KM
18 Mbps	14.64KM	25.60 KM
24 Mbps	11.66 KM	20.26 KM
36 Mbps	8.21 KM	16.85 KM
48 Mbps	3.72KM	12.23 KM
54 Mbps	1.84 KM	7.32 KM

Table 1 Evaluated Maximum Distance

6.3 Planning Radio Path

For the wireless communication, the Line-of-Sight (LOS) will be the major issue over building up the wireless link. This evaluated procedure is to reduce the obstructions and to avoid the multiple-path signal degrading the communication quality.

The first requirement is the Line-of-Sight (LOS) between the both sides' Antennas. The radio line-of-sight concept is the area along the radio linking path through which is the bulk of the radio signal power travels. The area is known as the first Fresnel Zone of the radio link. For the radio link, it should avoid to be affected by obstacles in this path, including the ground within 60% of the first Fresnel Zone.

The following figure illustrates the concept of a good radio line-of-sight.

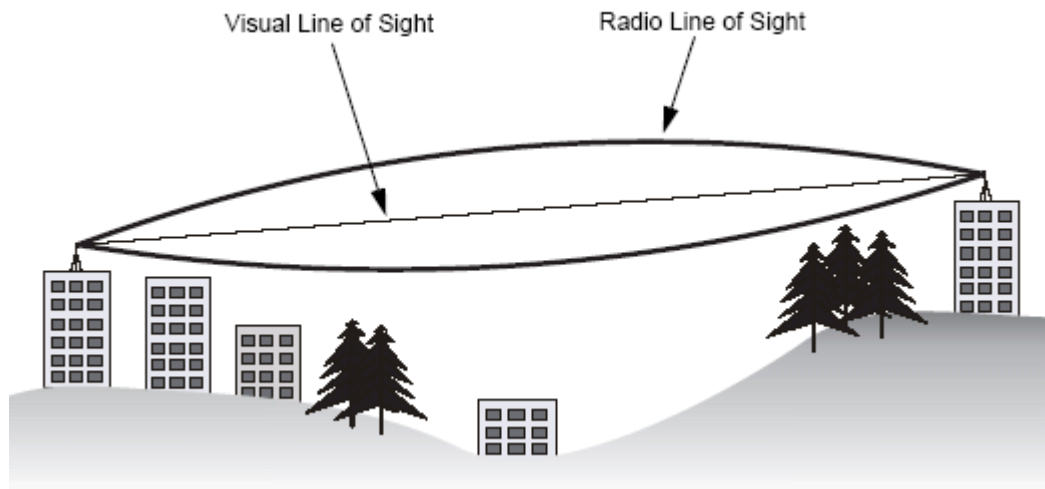

Picture 23 Line-of-Sight (LOS)

If there is any obstacle in the radio path, it may still be a radio link but the quality and the signal strength will be affected. Ensuring the maximum clearance from objects on a path is important to locate the antennas and the height. For the long-distance links, the radio signals might be lost partially due to the non-LOS issue.

As we setup the radio path for the wireless bridge link, it needs to consider these factors:

- Avoid any partial line-of-sight between the antennas.
- Be aware of trees that may be near the path or obstruct the path.
- Make sure there is enough clearance from buildings and there is no any building or construction blocking the path.
- Check the land topology between the antennas using topographical maps, aerial photos, or even satellite image data.
- Avoid a path that may have the temporary blockage due to the moving objects, such as cars, trains, or aircrafts.



Note: For the wireless link less than 500 m, the IEEE 802.11a radio signal will tolerate some obstacles in the path and may not even require a visual line of sight between the antennas.

6.3.1 Antenna Height

The reliable wireless linkage usually depends on the both sides' antennas for a clear radio line of sight. The minimum height is up to the link distance, obstacles that may be in the path, topology of the terrain, and the curvature of the earth (for links over 2 miles). For the long-distance links, the mast or the pole may need to be constructed to attain the minimum required height. The following table is for you to estimate the required minimum clearance above the ground or path obstruction.

Total Link Distance	Max Clearance for 60% of First Fresnel Zone at 5.8 GHz	Approximate Clearance for Earth Curvature	Total Clearance Required at Mid-point of Link
0.25 mile (402 m)	4.5 ft (1.4 m)	0	4.5 ft (1.4 m)
0.5 mile (805 m)	6.4 ft (1.95 m)	0	6.4 ft (1.95 m)
1 mile (1.6 km)	9 ft (2.7 m)	0	9 ft (2.7 m)
2 miles (3.2 km)	12.7 ft (3.9 m)	1 ft (0.3 m)	13.7 ft (4.2 m)
3 miles (4.8 km)	15.6 ft (4.8 m)	2 ft (0.6 m)	17.6 ft (5.4 m)
4 miles (6.4 km)	18 ft (5.5 m)	3 ft (0.9 m)	21 ft (6.4 m)
5 miles (8 km)	20 ft (6.1 m)	4 ft (1.2 m)	24 ft (7.3 m)
7 miles (11.3 km)	24 ft (7.3 m)	8 ft (2.4 m)	32 ft (9.7 m)
9 miles (14.5 km)	27 ft (8.2 m)	14 ft (4.3 m)	41 ft (12.5 m)
12 miles (19.3 km)	31 ft (9.5 m)	24 ft (7.3 m)	55 ft (16.8 m)

Table 2 Estimated LOS Clearance

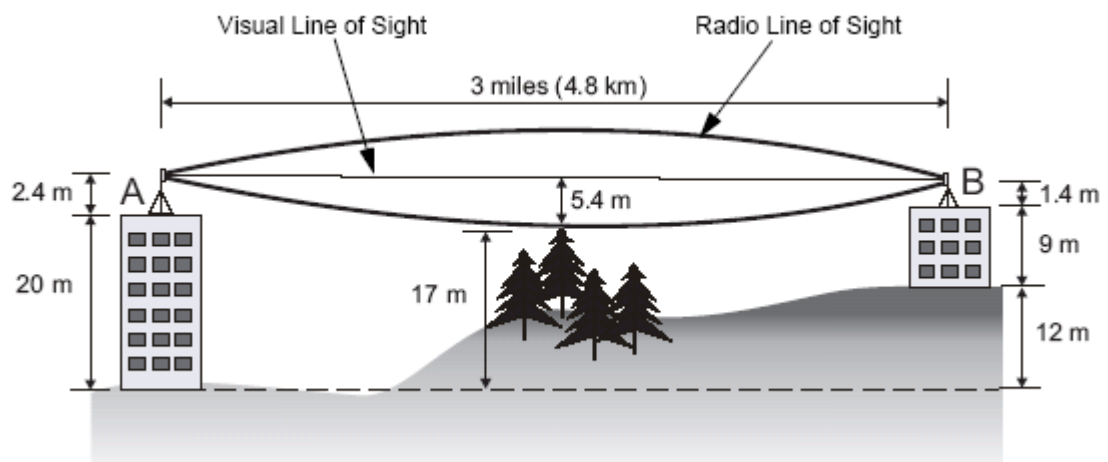

Picture 24 Antenna Height

For example, the wireless link between the building A and the building B is located three miles (4.8 km) away. There is a tree-covered hill in the mid-way. From the table above, it can be seen that for a three-mile link and the object clearance required at the mid-point is 5.4 m (17.6 ft). The tree-covered hill height is at an elevation of 17 m (56 ft), so the antennas linkage on both sides need to be at least 22.4 m (73 ft) high. The building A is six stories high or 20 m (66 ft), so the mast or pole with 2.4 m (7.9 ft) must be constructed on its roof to meet the required antenna height. The building B is only three stories high or 9 m (30 ft) but it is located at an elevation that is 12 m (39 ft) higher than the building A. A mast or pole is required to mount an antenna at the required height 1.4 m (4.6ft) on the roof of building B.

6.3.2 ANTENNA TYPES

Each antenna must have the FCC-approved for use with the bridge. The antennas provide omnidirectional, directional, or diverse coverage and support various communication distances. Antennas are available with different gain ratings and coverage areas. The following figure is to show you one of these combinations, for example; the Bridge comes with the omnidirectional Antenna.

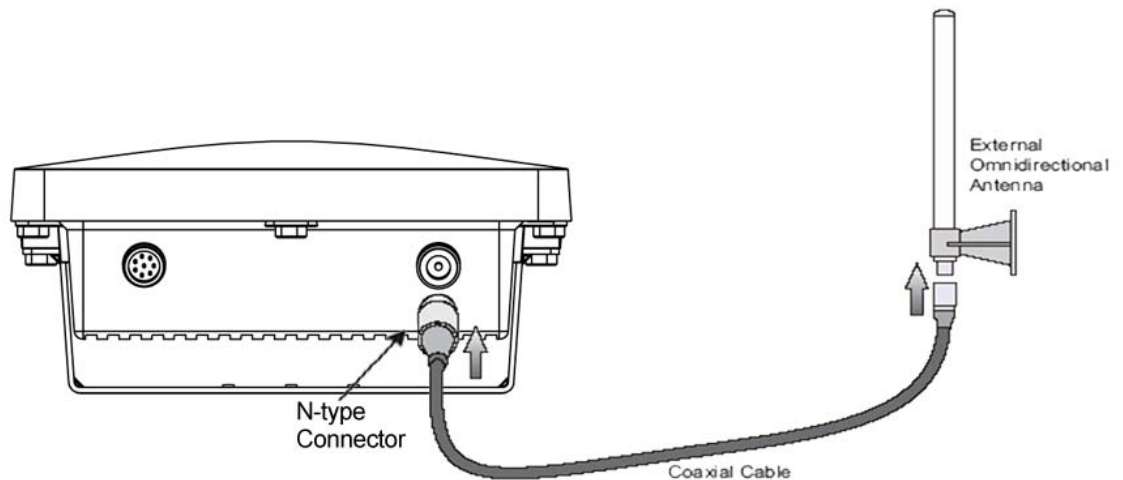

Picture 25 The Bridge with the omnidirectional antenna

6.3.3 Antenna Cable

An antenna cable introduces signal losses in the antenna system for both the transmitter and receiver. To reduce signal loss, you should minimize the cable length and use only low-loss antenna cable to connect your radio device to the antenna.

6.3.4 Weather Affection

The weather plays one of major matters to the antenna performance for the wireless communication. The raining day, the lightning day, the cloudy day, or the windy day will make a quite big impact to the both side antennas over the communication results. It will also cause the communication quality unstable.

7 Field Installation

7.1 Unpack the shipment

7.1.1 Required Tools:

- Utility knife
- Clean and flat working surface

Check the equipments and the installation kits against the packing list to ensure that the equipment part numbers, parts, and the ancillary equipments included in the shipment match what is specified on the packing list. The shipment consists of an ODU and an installation kit in the container. If there is any difference from the packing list, you will need to contact the sales representative.

Please, inspect the equipment to see if there is any shipping damage. If it does have any damage, you could contact the sales representative for repair or replacement.

7.1.2 Product

- AirEther BR108 Outdoor Bridge x 1

7.1.3 Accessories

- Outdoor Mounting Kits x 1(Set)
- DC Injector /RJ45 (RJ45DI-48) x 1
- AC/DC Power Supply (DC48V 1.37A) x 1
- Installation Guide x 1
- Utility and User's Manual CD x 1

7.2 Installing the ODU

7.2.1 Required Tools:

- 1) Screw Driver
- 2) Sealing Type

7.2.2 Installed Accessories:

- 1) Antenna Mounting Set x 1
- 2) Grounding rod x 1
- 3) Waterproof Seal
- 4) Ethernet Cable x 1

7.2.3 How to Mount the Bridge:

You could follow the steps to mount the bridge as below:

Installation Diagram

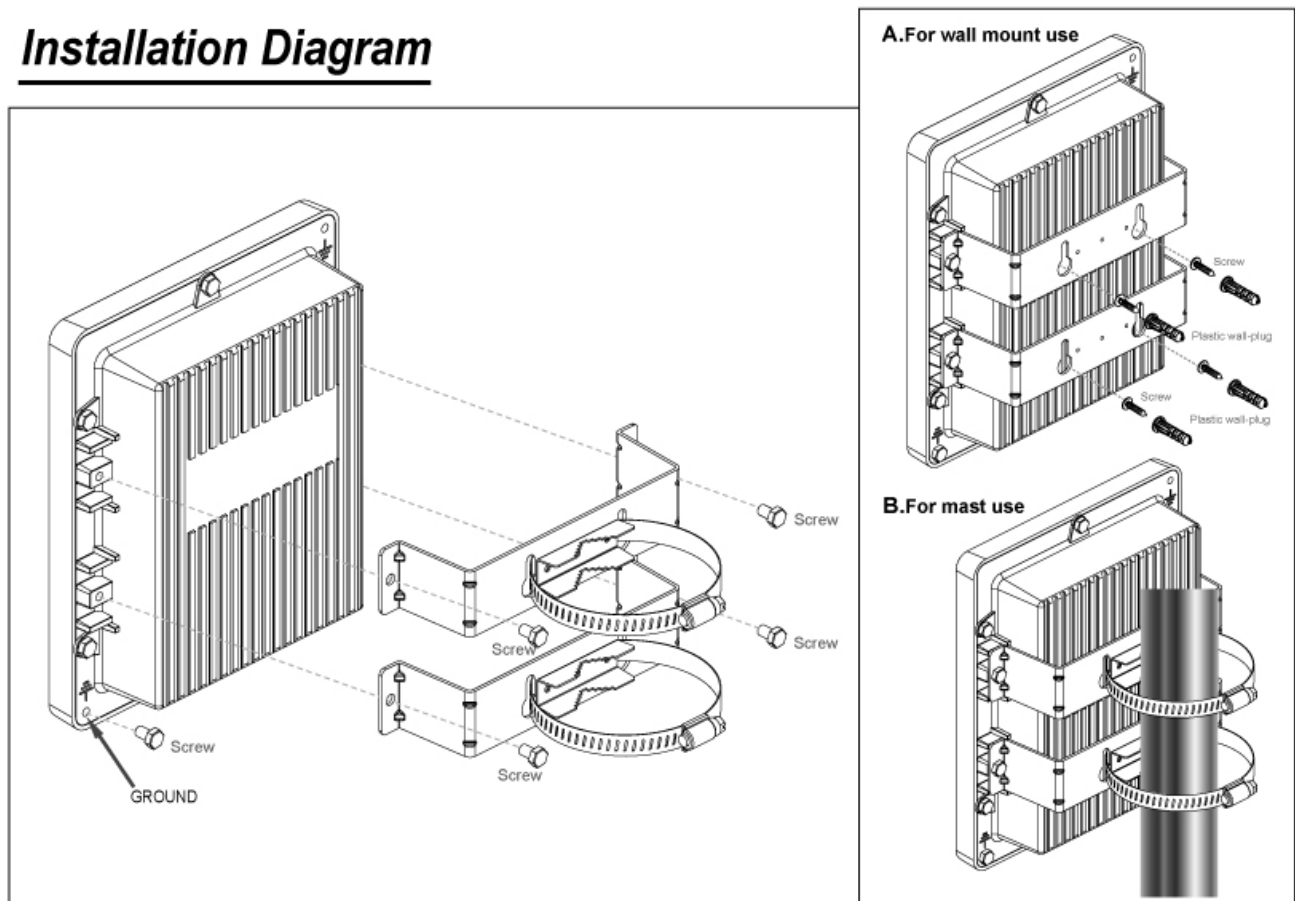

Picture 26 Mount the ODU on the Mast or the Pole

7.2.4 Connecting the cable

An Ethernet cable connects to the power over Ethernet (P.O.E.) output port. Another Ethernet cable (RJ – 45; the crossover cable) connects to the Power over Ethernet (P.O.E.) input port. The POE AC Adapter supplies the AC power to the bridge system.

7.2.5 General Antenna and Safety Tips

When installing an antenna, follow these general tips:

- ◆ For most elevated antenna installations, we recommend you to ask the professional installers for proper installation and safety.
- ◆ For the safety reasons, you are recommended never to touch a high-gain antenna when it is transmitting or point it at any part of your body.
- ◆ Please, follow carefully the instructions with your antenna.
- ◆ Keep antennas away from metal objects/obstructions (heating and air-conditioning ducts, large ceiling trusses, building superstructures, and major power cabling runs).
- ◆ Use a directional antenna when you establish a link between two buildings. A directional antenna must be properly aligned to the point at the other antenna.
- ◆ Locate an omnidirectional antenna in the middle of the desired coverage area if possible.
- ◆ Place the antenna as high as possible to increase the coverage area.
- ◆ Outdoor antennas should be mounted at a sufficient height to prevent the radio path from above the obstructions such as trees and buildings.
- ◆ Antenna towers should keep a safe distance from overhead power lines. The recommended safe distance is twice the tower height.
- ◆ Use the special ground rods and follow the National Electrical Code for the outdoor antenna and tower grounding properly.
- ◆ To prevent water from entering into the antenna cable and be sure to seal all external cable connectors using commercial products just like coax compatible electrical tape and Coax-Seal.

7.2.6 Basic Antenna Alignment

When you use directional antennas to communicate between two bridges, you must manually align the antennas for proper bridge operation. Directional antennas have greatly reduced radiation angles. The radiation angle is approximately 25 to 30 degrees, and the parabolic dish antennas radiation angle is approximately 12.5 degrees.

You can use the link-testing tool to help measure the alignment of two antennas after the bridges are associated. The link-testing tool provides you information you can use to gauge the alignment.

7.2.7 ESD Protection

The ESD (electrostatic discharge) can damage the electronic components. The ESD can cause latent damage that results in premature failure even if components remain function. The equipments must be properly grounded. The technical people always need to wear the proper ESD grounding straps and make sure the ESD grounding strap connecting to the ESD connector during equipment installation, maintenance and repairs.

7.2.8 Review the Installation

When you finish installing the bridges and aligning the Antennas, you need to secure all cable connection is tight properly.

- Secure the Antenna mounting set is tight after the alignment.
- Check the cable connection is between the Antenna and the bridge is tightly.
- Make sure the grounding strip is properly connected to the Ground.
- Check the cable to POE adapter is connected correctly.
- Make sure the cable from the PC or the notebook to the POE adapter is connected appropriately.
- Make sure the POE adapter's light is on.
- Make sure you use the right cables during the installation.
- Make sure all connectors are sealed with the waterproof seal.
- Configure the ODU with the setting you want before the field installation.
- Check if the both side bridges having the same radio settings.
- Make sure you set up the both MAC address on each side

After taking all of these checks, you need to use the Web UI to test the link quality and to see if the RSSI value is in the right value range. You might need to do the Antenna alignment again if the performance is not good enough.

Appendix A

GLOSSARY

Auto Reboot	Specifies the enable/disable of auto reboot function for auto recovery.
Authentication Type	Specifies open-system or shared key.
Authentication / Deauthentication	Always 0 for Bridge
Bridge Distance	Enter the value (1 – 28 KM) to specify the distance between a pair of bridges.
Cipher Advertised	Specifies current state of advertised cipher negotiations, AES and/or WEP, and None.
CRC Errors	Specifies the number of receive CRC errors.
Data Rate	Specifies rate of data transmission. Best selection will adapt the rate to the best available.
Data / Management / Control	Packets can either be data, control, or management. Specifies the number of packets sent and received for each.
Discarded Frames - receive	Specifies the number of receive discarded frames.
Discarded Frames - transmit	Specifies the number of transmit discarded frames.
DMA Errors – receive	Specifies the number of receive DMA errors.
DMA Errors – transmit	Specifies the number of transmit DMA errors.
Duplicate Frames	Specifies the number of receive duplicate frames.
Encryption	Specifies the enabled state of encryption either yes or no.
Errors	Specifies the error count for both transmit and receive.
Excessive Retries	Specifies the number of transmit excessive retries.
Fragment Length	Specifies the fragment length. Enter a value between 256 and 2346.
MSDU	Maximum service data unit. Specifies the number of packets sent and received by Bridge.
Multicast PHY Errors	Specifies the number of multicast packets both sent and received. Specifies the number of receive PHY errors.
Receive Errors	Specifies the number of receive errors.

RSSI AUX Output Specifies the activation of RSSI AUX Output for antenna alignment.

RTS/CTS Threshold Specifies the value of the RTS/CTS threshold. Enter a value between 256 and 2346.

State Current state of Bridge.

Transmit Power Specifies the level of transmit power. Choose the value of the transmit power from the dropdown menu.

Transmit Errors Specifies the number of transmit errors.

Appendix B

TROUBLESHOOTING

The bridges could not associate appropriately with each other:

- To make sure the cables is connected properly.
- To check the POE adapter's green light is on or not.
- To check the both Frequency settings are on the same channel or not.
- To check the data rate is matched with one and another through the statistic RSSI display or the advance setting inside the Frequency setting.
- To make sure you use the same encryption key on the both sides or during the bridge link.
- To check the Antenna is aligned appropriately before the Bridge's association.
- Correct MAC address entered in the master or slave bridge

If you experience the poor performance (high package loss rate) during the bridge link, it is better for to check the following items:

- To check the range is still inside the Antenna range limitation or not.
- To make sure the Antenna is aligned properly again.
- To make sure if there is no any obstruction in the middle of Line-of-Sign(LOS).
- To be sure there is no radio transmitter too close to the bridge s' Antennas and relocated the Antennas if you have some around.
- To check if you use too close frequency channels to cause the poor link and to set another channel.
- To ping one and another IP address to make sure it will reply or not.

If all recovery measures fail, the bridge still couldn't function properly and take this action as what we recommend:

- Do not open the bridge box by yourself.
- Contact the technical support experts for the troubleshooting.
- If you do open the bridge, you will lose the manufacture warranty.